

Abäke, *A fleet of mountain (Faceboat)*, 2017

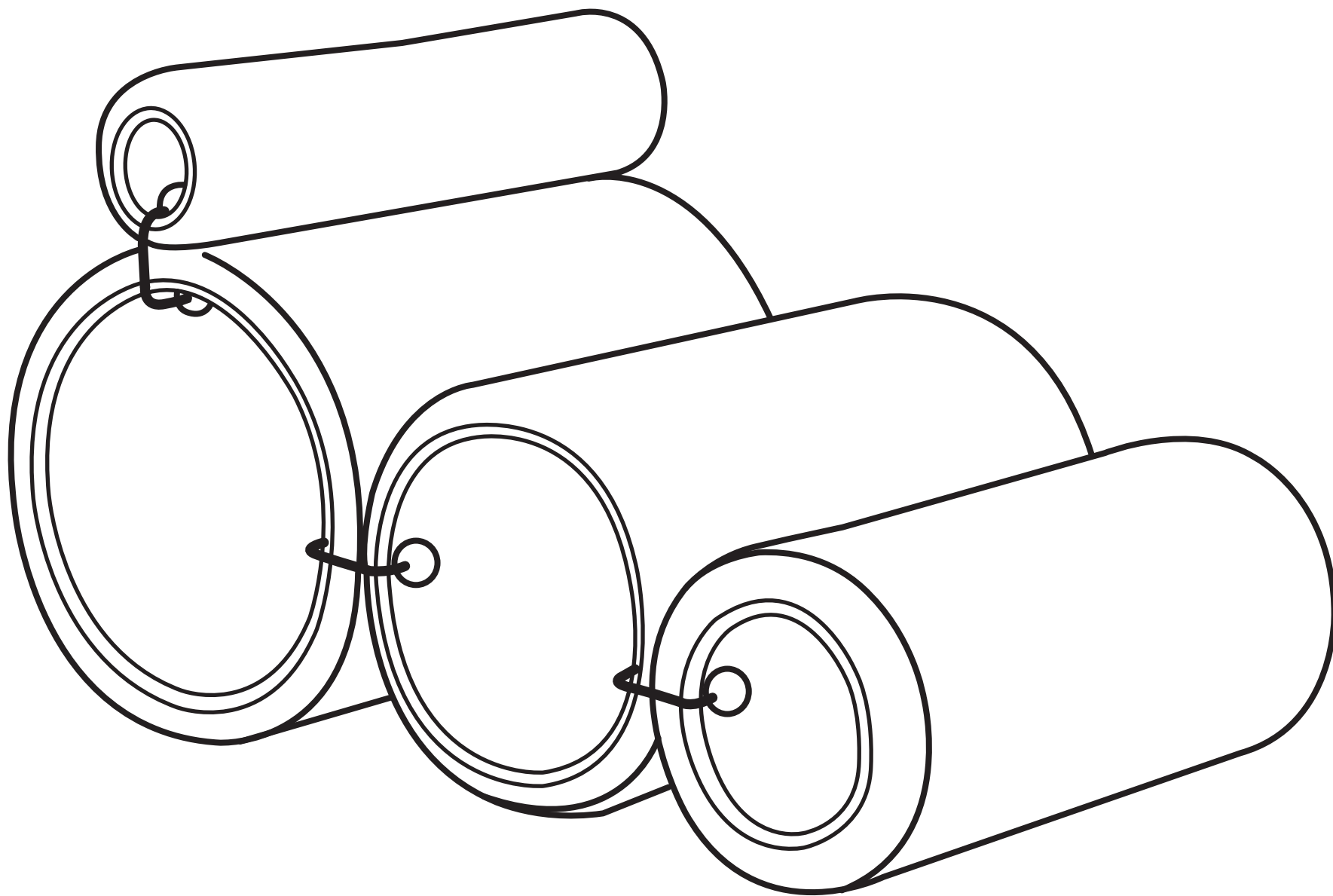

Joe Colombo, *Fauteuil Tubo*, 1969-1970



Raymond Pettibon, *No title (In spite of)*, 1982

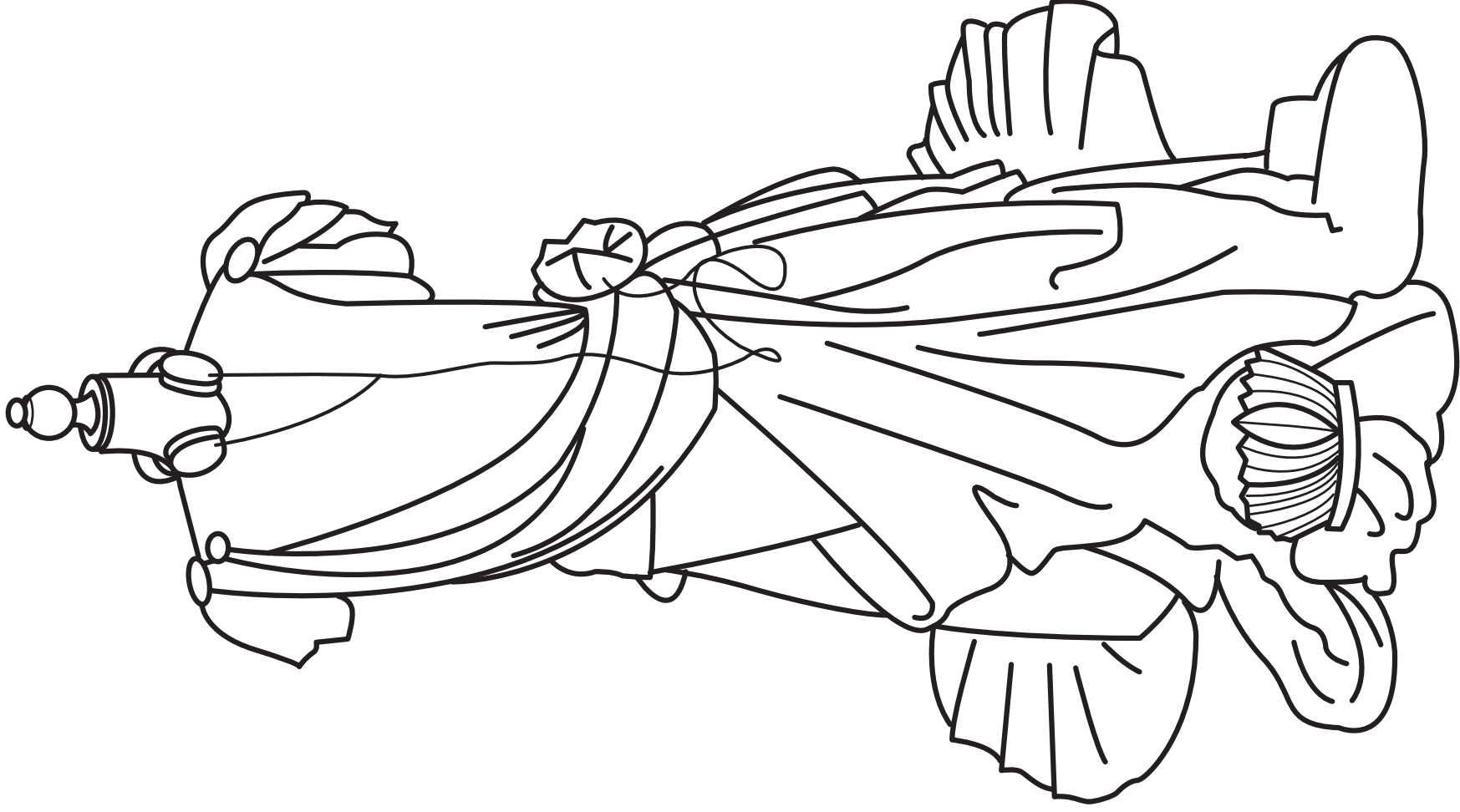

Lise Haller Baggesen, *Ms Peace in the US!*, 2016

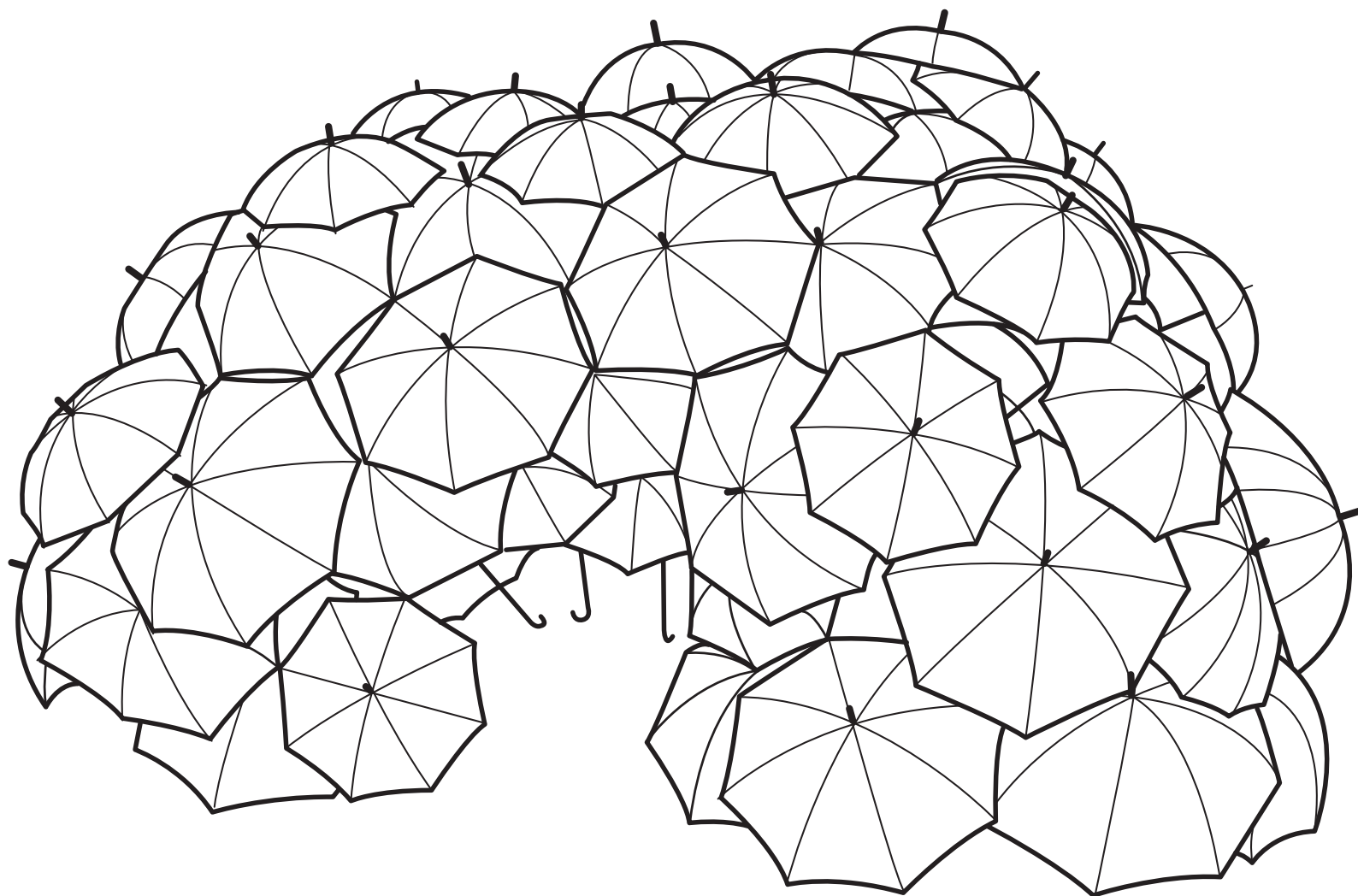

Kohei Sasahara, *Sunny*, 2016

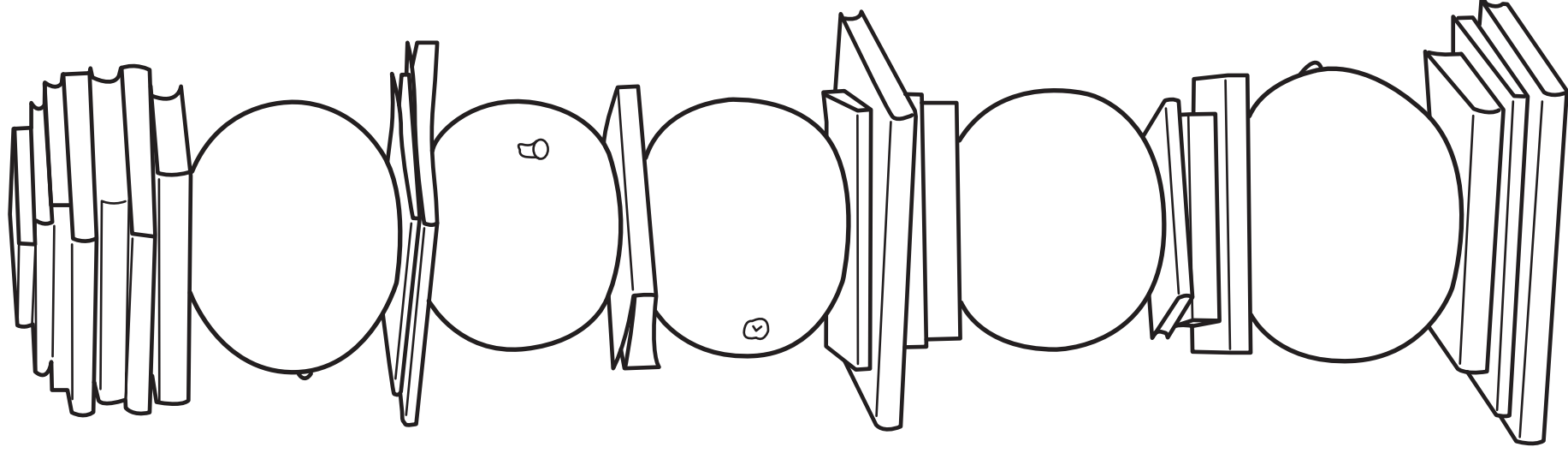

**Maddalena Fragnito de Giorgio, *Taboo***

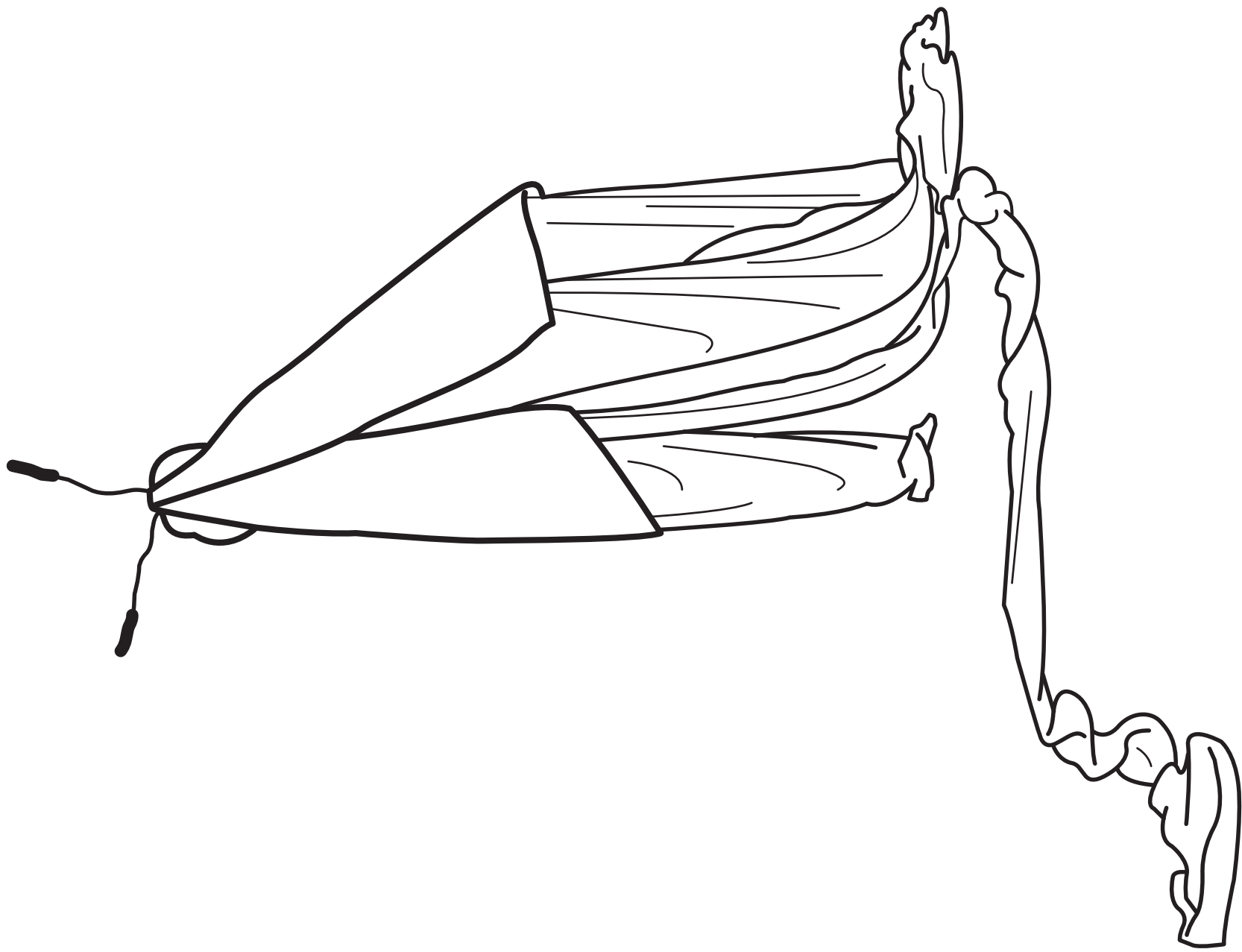

*Petrit Hailaj, Do you realize there is a rainbow even if it's night !? (red), 2017*



Tejo Remy, *Chest of Drawers*, 1991



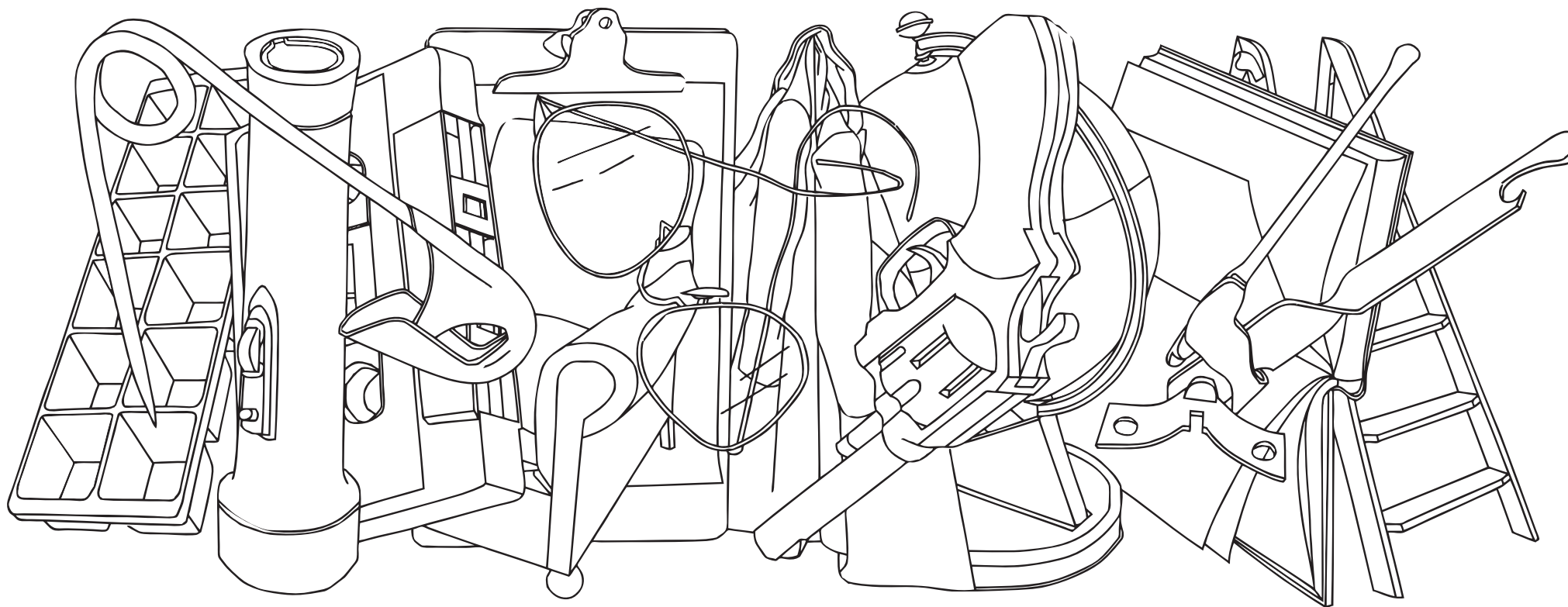

Michael Craig-Martin, *Modern Dance*, 1987



Marion Baruch, *Ron Ron*, 1972

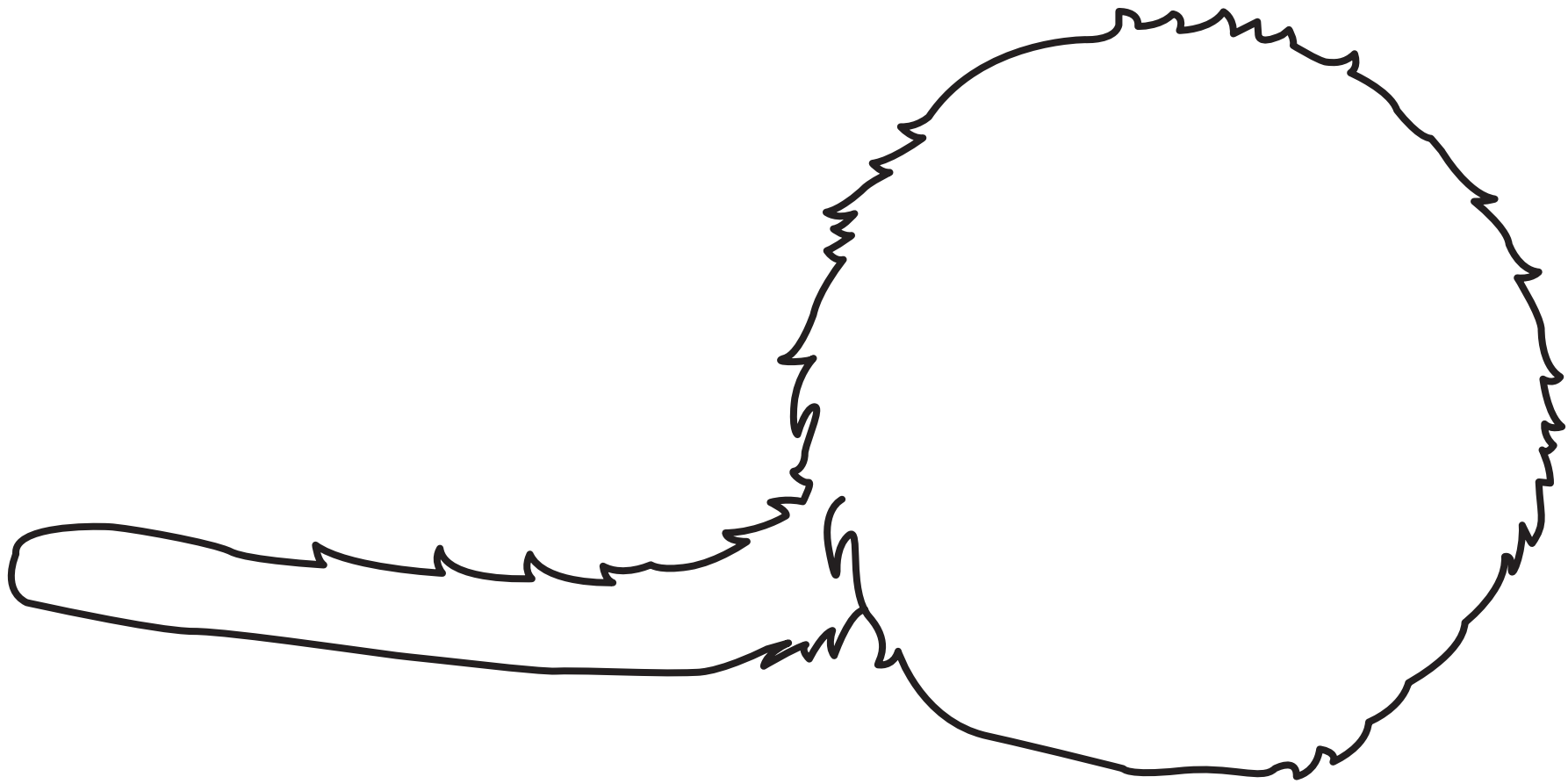

Marion Baruch, *Ron Ron*, 1972

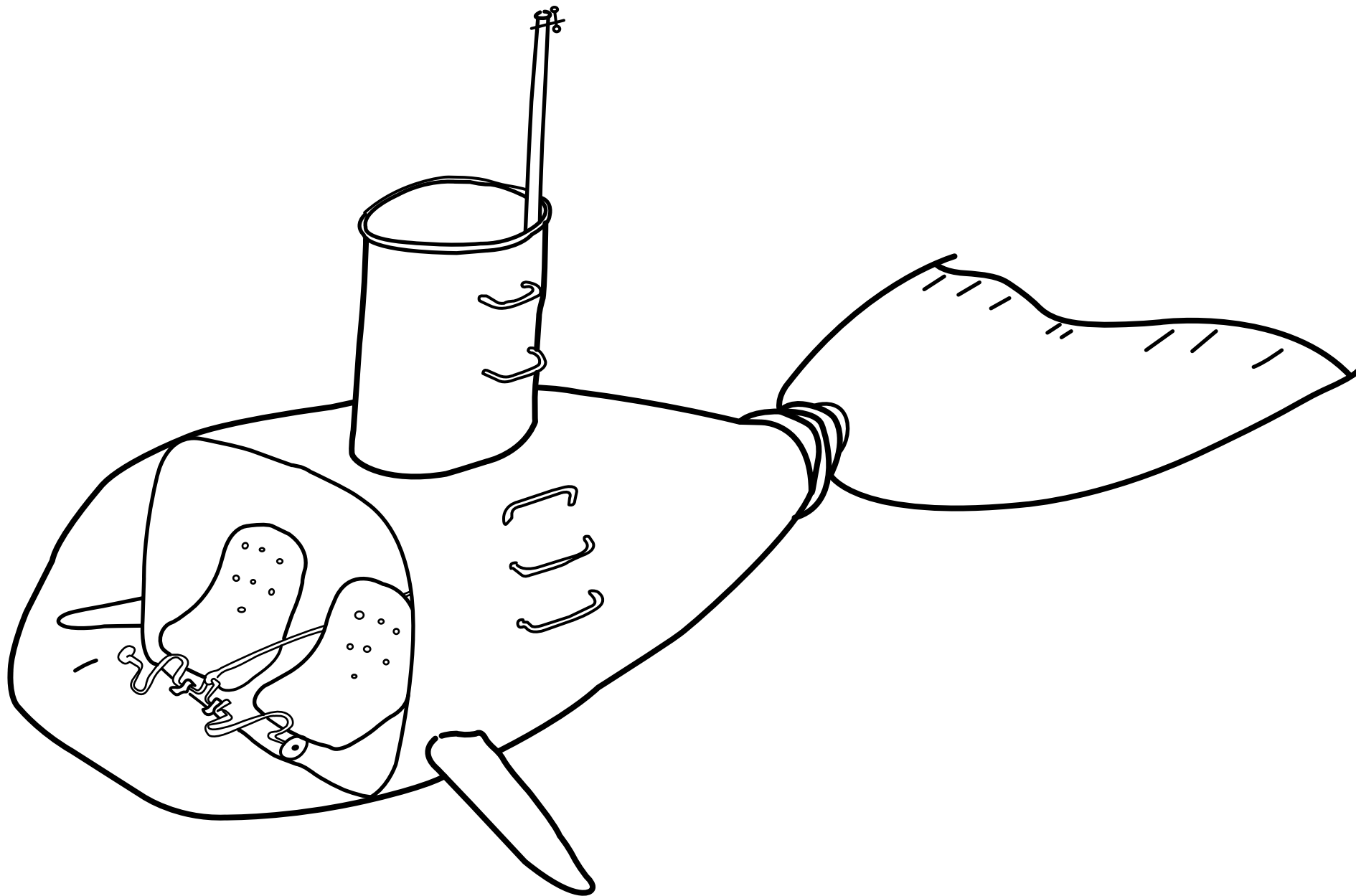

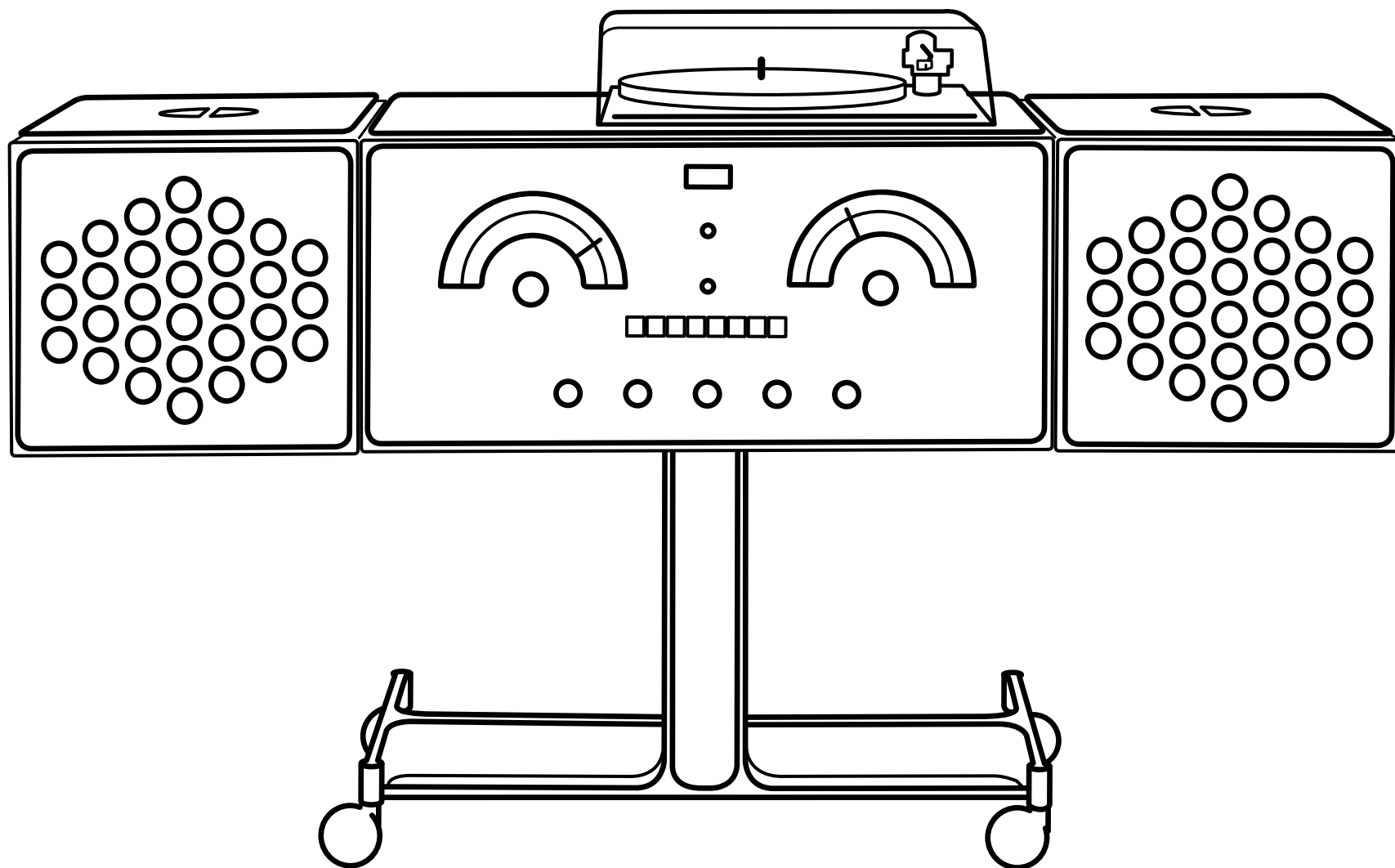

Pier Giacomo Castiglioni, *Chaîne stéréo RR126*, 1965



Présence Pantchounette, *Wham!*, 1982

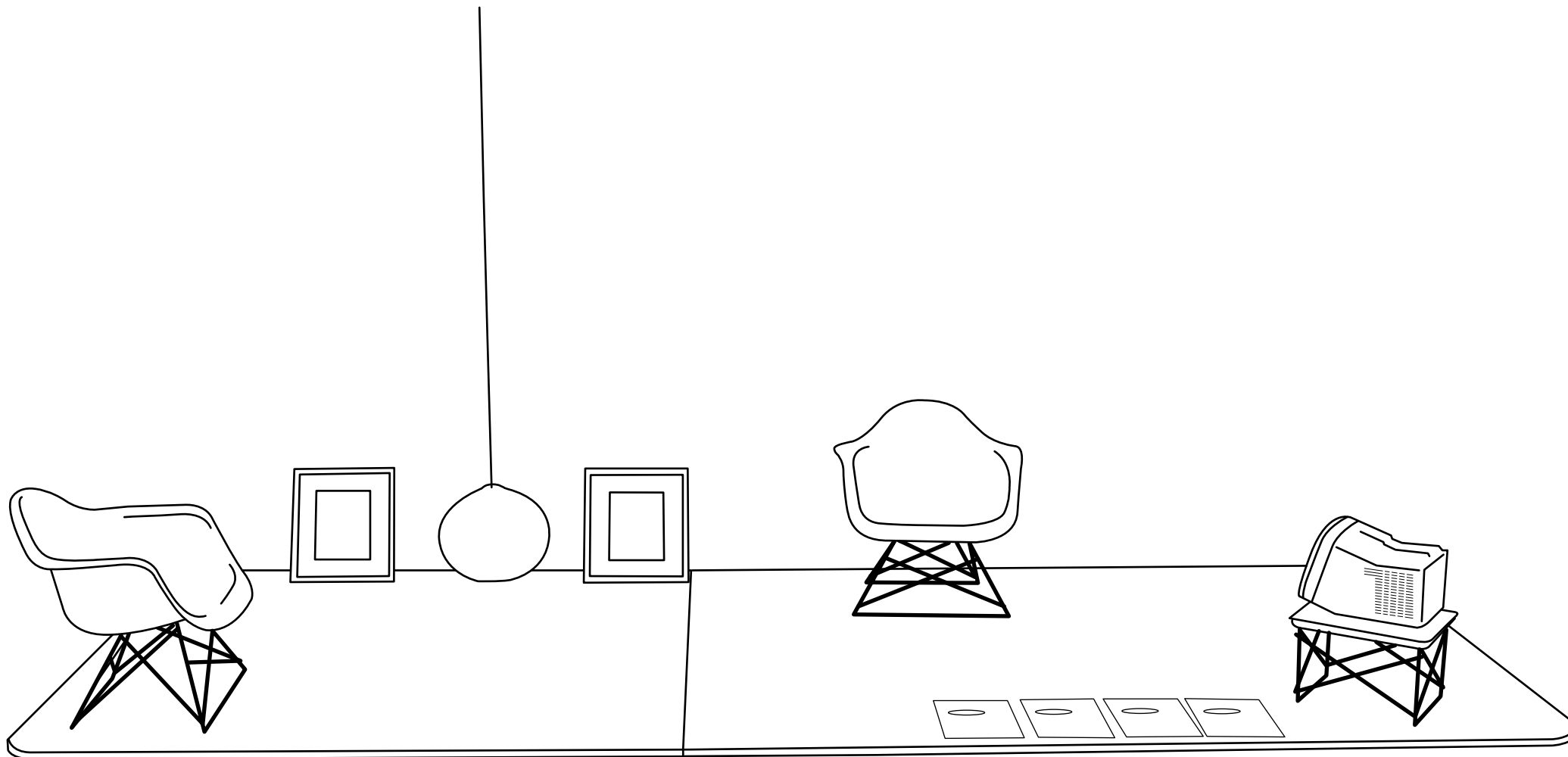

Dejanov & Heger, *Still Life (Plenty objects of desire)*, 1997

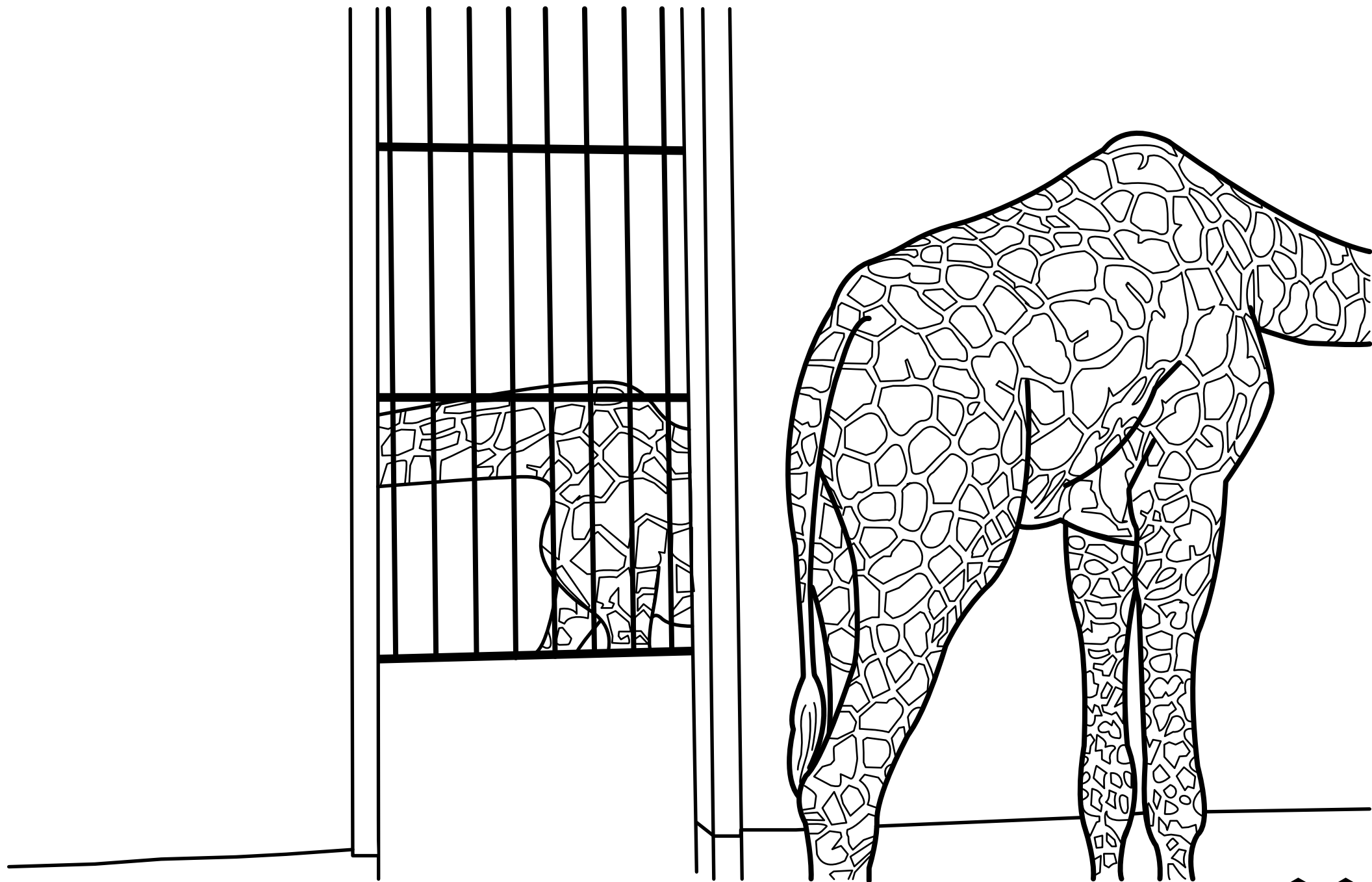

Michel Van den Eeckhoudt, *Girafes, Maubeuge*, 1981



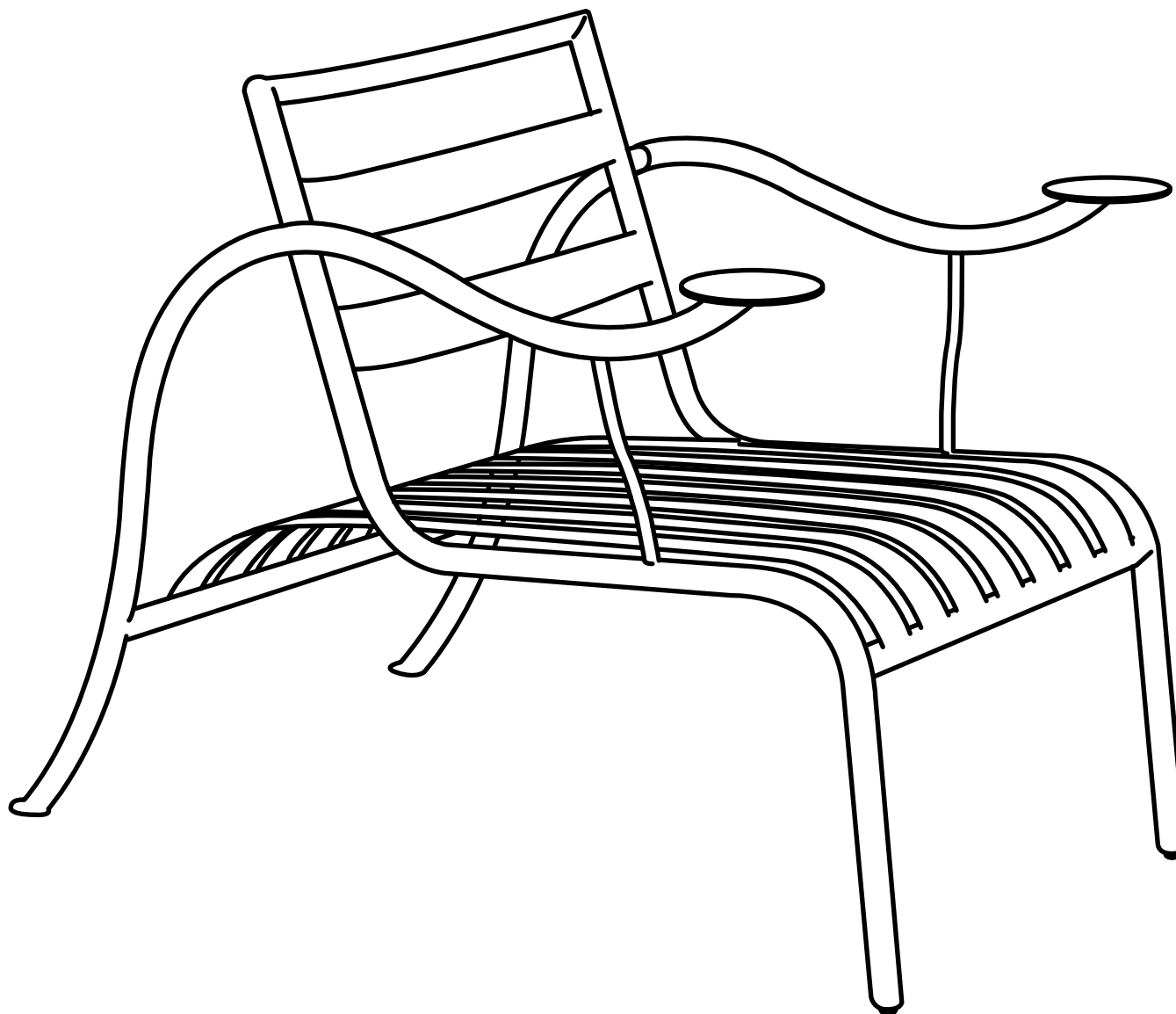

Jasper Morrison, *fauteuil Thinking Man's Chair*, 1986

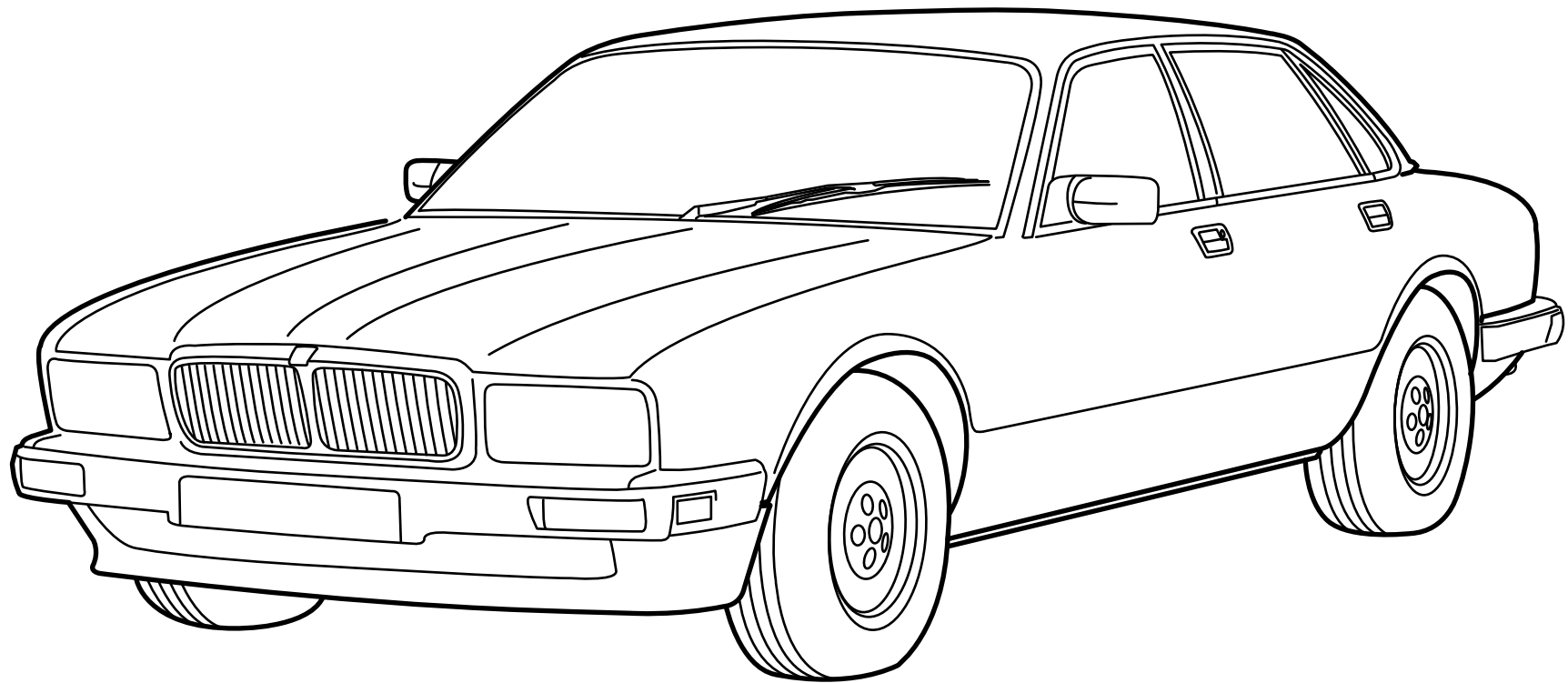

Frederik Van Simaey, *Close*, 2010



Christine Deknuydt, *Faire l'austruche*, 1991-1999

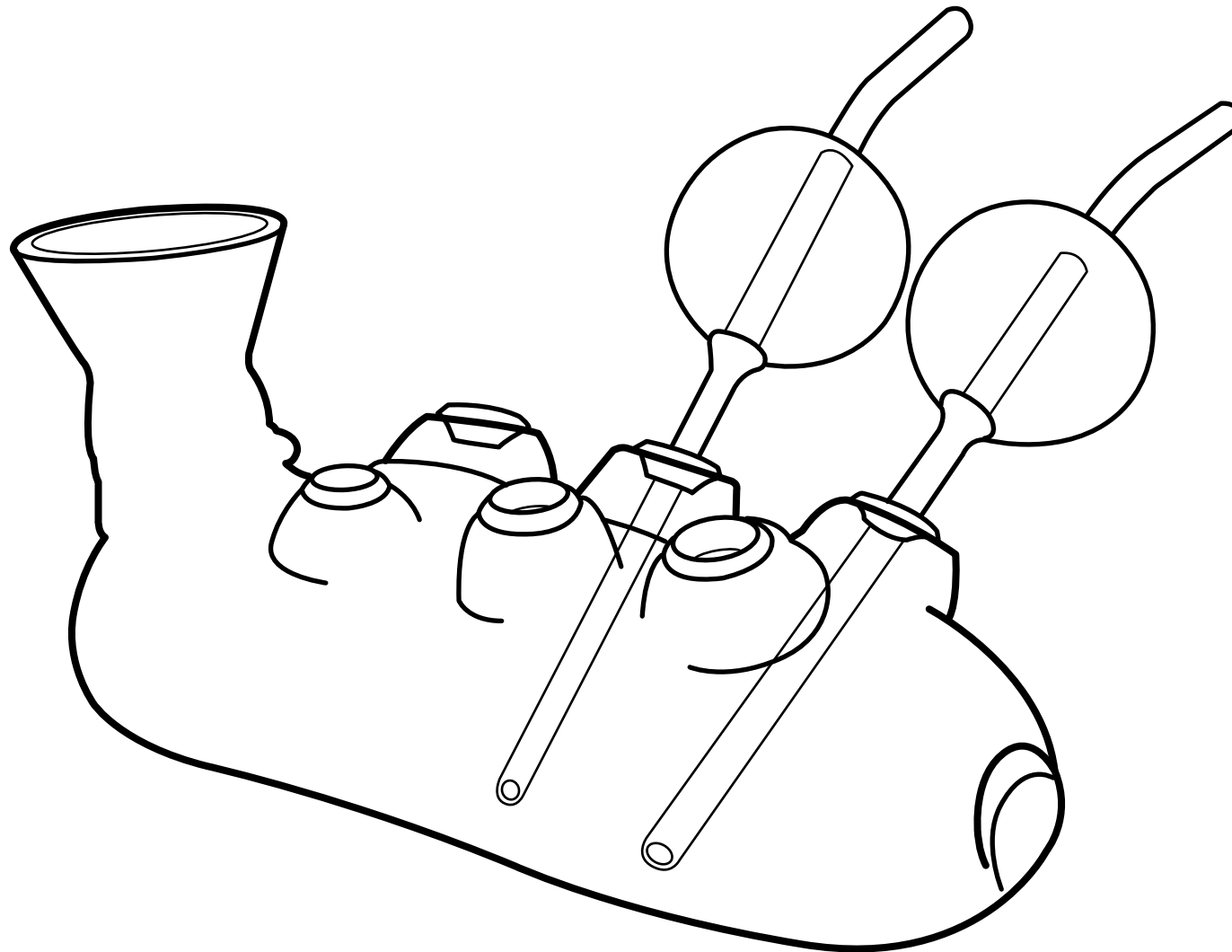

Vogt + Weizenegger, *Carafe taste : Dyonisos'stomac*, 2002

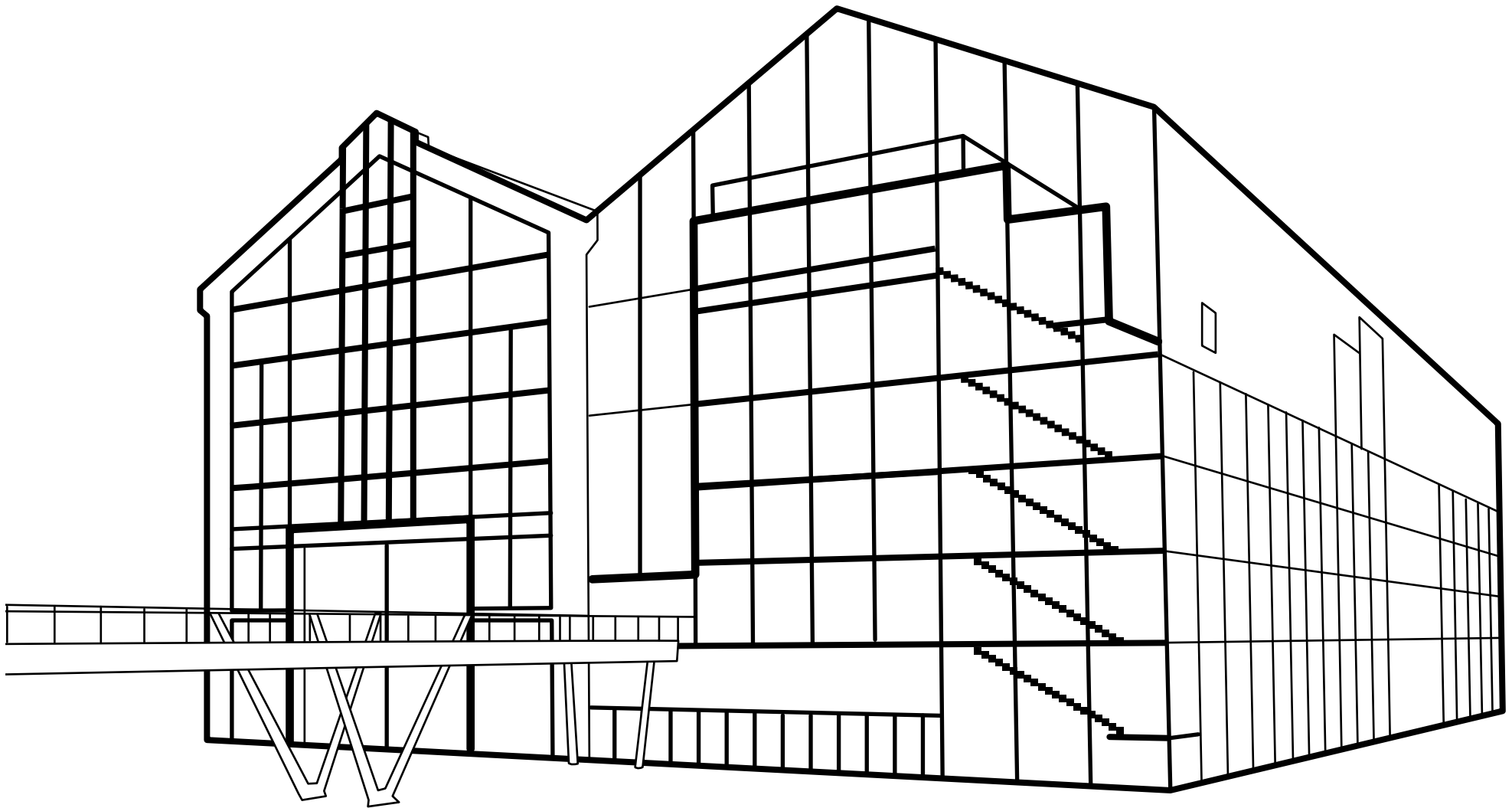

Lacaton & Vassal, *Frac Grand Large* — Hauts-de-France, 2013